

AXIAL CHECK VALVES

INNOVATION
IN THE PIPELINE



GOODWIN
INTERNATIONAL LTD

www.checkvalves.co.uk

Goodwin® International is globally approved for its design, manufacture and supply of Dual Plate Check Valves and Non-Slam Axial Check Valves to the world's hydrocarbon, energy and process industries - upstream, midstream, downstream. With a track record of supply of over 35 years, Goodwin® has developed an enviable reputation for quality and reliability of product at internationally competitive prices. This high quality product is supported by an organisation that has extensive experience, knowledge and skill sets to meet today's stringent end-user specifications and their quality management systems expectations.

Having a range of axially operated non-slam check valves enables Goodwin® International to provide cost effective technical solutions for those critical / severe pump and compressor applications where reliability and high performance are an absolute necessity. The Goodwin® Axial Check Valve is founded on 80 years of proven and established design, technology and experience.

Based in the United Kingdom, Goodwin® sells internationally exporting to over 80 countries and providing its customers with outstanding service and support. Listed amongst its customers are the vast majority of the world's end users, both oil majors and national oil companies, and national and international engineering contractors.

Goodwin® Axial Check Valves

3 Valve Types

- Type Z - Solid Disc: Sizes 1"-10" (DN 25 - 250)
- Type N - Ring Disc: Sizes 12"-88" (DN 300 - 2200)
- Type NZ - Ring Disc: Sizes 12"-88" (DN 300 - 2200)

3 Face-to-Face Options

- NK, NC - Compact Face-to-Face
- ZB, NB, NZ - Long Face-to-Face
- ZD, ND, NA - API 6D Face-to-Face

5 Different Body Styles

Wafer; Flanged; Solid Lug; Hub-End; Compact Flange; Butt Weld End

Sizes

1" - 88" (DN 25 - DN 2200)

Pressure Classes

ASME 150 - 2500, API 2000 - 20000, PN 10 - 400

Materials

Cast and Ductile Irons; Carbon Steels; Stainless Steels; Duplex and Super Duplex Stainless Steels; Aluminium Bronze; High Nickel Alloys; Titanium

Features

Designed, manufactured, assembled and tested in accordance with Quality Assurance System registered by BSI to BS EN ISO 9001.

Certifiable in compliance with European Pressure Directive (PED) 2014/68/EU to meet customer requirements when specified.

All bodies and discs certified to BS EN 10204 3.1 as a minimum.

No leakpath to atmosphere - No fugitive emissions.

Firetested design. Firetest approved and certified to API 6FA, API 6FD and BS EN ISO 10497.

Suitable for all installation positions

Solid Disc
Type ZB

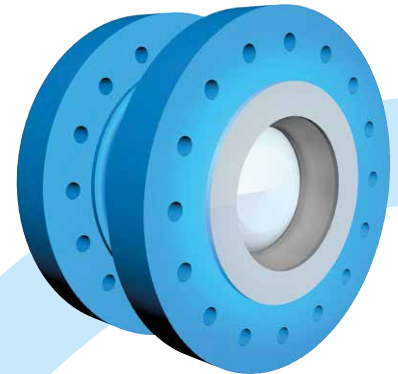

Ring Disc
Type NB

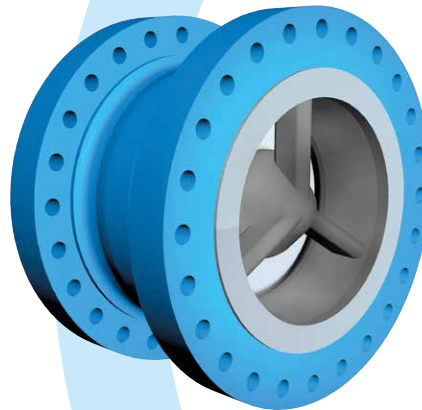

Ring Disc
Type NZ

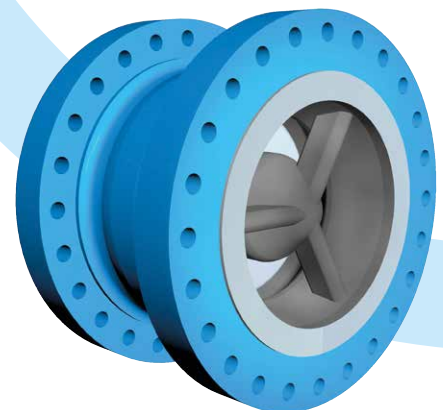

Axial Check Valve Specifications

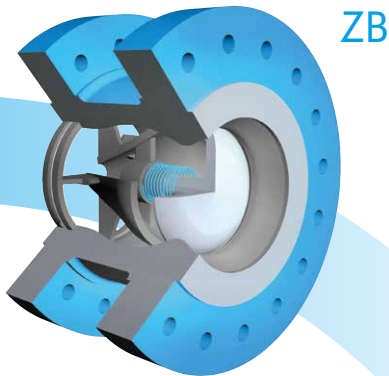

ZB

Type Z Solid Disc

The axial design allows for a streamlined flow path around the disc and diffuser providing high pressure recovery, thereby minimising pressure drop across the valve. This efficient design combined with the highly responsive non-slam operation make this valve ideal for high head, critical pump applications.

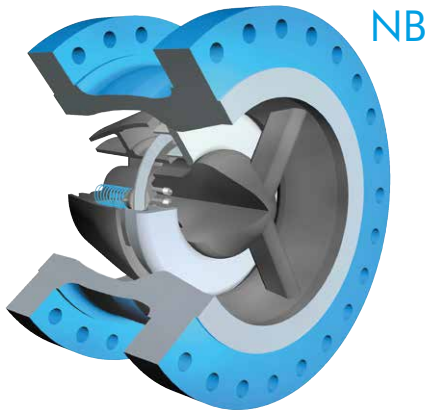

NB

Type N Radially Guided Ring Disc

The unique balanced ring disc design has friction-free disc guiding ensuring the disc remains light and responsive even in large sizes, essential for rapid non-slam closure. Mounted on a multiple spring and radial guide assembly, the disc moves freely without any frictional forces. Combining two ring-shaped annular flow paths with the excellent pressure recovery properties provided by the diffuser, the minimal pressure drop across the Type N valves gives lifetime energy savings when compared to more conventional check valve designs.

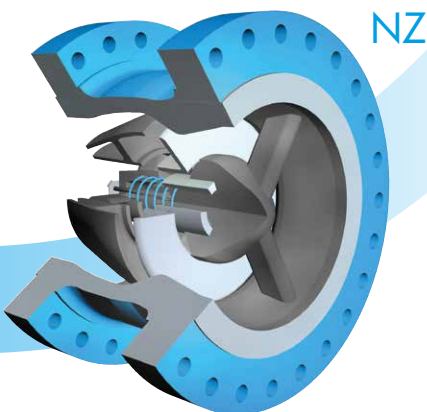

NZ

Type NZ Centrally Guided Ring Disc

With the Type NZ the ring disc is centrally guided with a single spring. Using the same valve body as the Type N and with inner and outer disc diameters being the same in the two valves, the Type NZ provides the same internal flow profile and, consequently, the same minimal pressure drop as the Type N. The Type NZ displays the same dynamic behaviour as the Type N as the disc stroke is identical in the 2 valves and the friction in the Type NZ is negligible as the disc slides "balanced" on the guide bush.

All Goodwin Axial Check Valves offer the following features:

- Non-slam closure
- Metal sealing
- Low pressure loss
- High degree of shut-off
- Maintenance free
- Choice of face-to-face length

Size range: 1" - 10" (DN 25 - DN 250)
Pressure Class: ASME 150 - ASME 2500
API 2000 - API 10000

Type ZB This is Goodwin standard valve for sizes 1" – 10".
With its optimum designed aerodynamic flow path through
the valve the ZB results in very low pressure losses.

Type ZD As Type ZB but with API 6D face-to-face dimensions.

The Z range is suitable for all liquid and gaseous fluids.

Size range: 12" - 88" (DN 300 - DN 2200)
Pressure Class: ASME 150 - ASME 2500
API 2000 - API 10000

Type NK The NK is the Goodwin standard lower cost solution where
marginally higher pressure drops can be accepted.
It offers the customer a shorter face-to-face length and lower
weight than the Type NB.

Type NB The NB is the Goodwin standard long face-to-face valve
for 12" and larger, providing optimum pressure recovery
performance and, hence, minimum pressure loss.

Type ND As Type NB but with API 6D face-to-face dimensions.

The N range is suitable for all liquids.

Size range: 12" - 88" (DN 300 - DN 2200)
Pressure Class: ASME 150 - ASME 2500
API 2000 - API 10000

Type NC The NC is the Goodwin standard lower cost solution where
marginally higher pressure drops can be accepted.
It offers the customer a shorter face-to-face length and lower
weight than the Type NZ.

Type NZ The NZ is the Goodwin standard long face-to-face valve
for 12" and larger, providing optimum pressure recovery
performance and, hence, minimum pressure loss.

Type NA As Type NZ but with API 6D face-to-face dimensions.

The N range is suitable for all gaseous fluids.

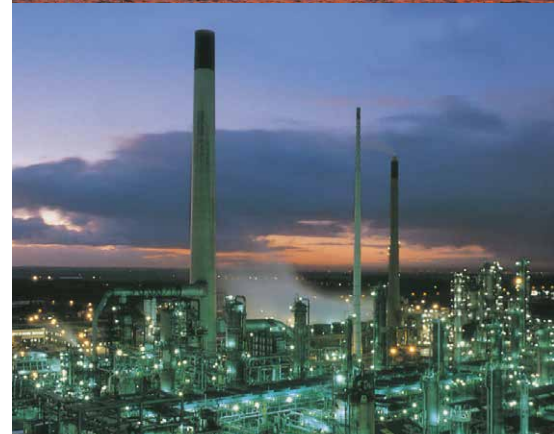

Solid Disc

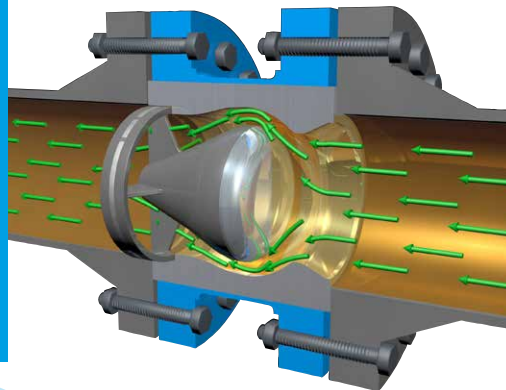

Facilities & Resources

Goodwin's Check Valve manufacturing facilities in Stoke-on-Trent, England, comprises of a Steel and Super Nickel alloy foundry (Goodwin Steel Castings) and a well equipped CNC machine shop with full design, fabrication, inspection and test facilities (Goodwin International).

The BS EN ISO 9001 foundry specialises in producing high integrity, pressure vessel castings from a few kilos to 18,000 kg in weight. The materials cast by the foundry include ductile and Ni-Resist® irons, carbon and low alloy steels, stainless steels, duplex stainless steels and super nickel alloys such as Hastelloy® and Alloy 625. Goodwin's ability to produce the special alloys is enhanced by its in-house 10 tonne AOD refining furnace.

The design, machine and assembly shops cover some 30,000m² and are equipped with 46 modern CNC machine tools that are the core of the production and are supplemented by many conventional machine tools.

The test facilities include six hydraulic hydrostatic test rigs, the largest of which has a 2500 tonne hydraulic ram, and two pneumatic test rigs. Cryogenic testing is also carried out on site where valves are cooled by nitrogen vapour/ liquid nitrogen at -196°C and leak tested with helium gas.

Valve design is carried out using 3D CAD and is verified on computers utilising finite element analysis and Flow Simulation programs. Both the foundry and the design, machining, assembly and test facilities are audited and accredited to BS EN ISO 9001.

Extensive in-house testing and laboratory facilities are available including:-

- Hydrostatic Pressure Testing (25000psig/1725barg)
- High Pressure Gas Testing (20000psig/1380barg)
- Low Temperature (-46°C) and Cryogenic Temperature (-196°C) Pressure Testing
- High Temperature Pressure Testing to 550°C
- Helium Leak Testing (Mass Spectrometer)
- Tensile / Bend / Impact / Hardness / Testing
- Corrosion Testing
- Metallography
- Magnetic Particle
- Dye Penetrant
- Ultrasonic Examination
- Radiography
- Chemical Analysis
- Alloy Verification / Positive Material Identification (PMI)
- Feritscope Verification
- CMM Measurement
- Laser Measurement
- Testing to API 6A all PSL levels
- Finite Element Analysis
- Computational Fluid Dynamics
- Scanning Electron Microscope

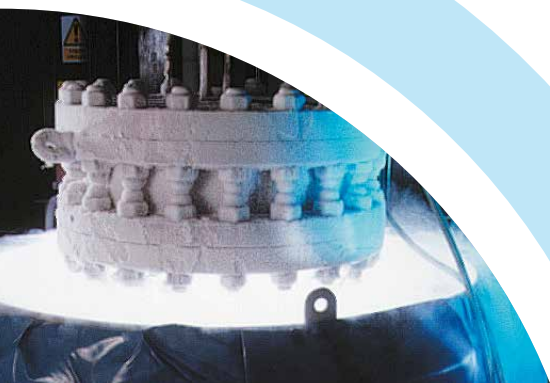

Ring Disc

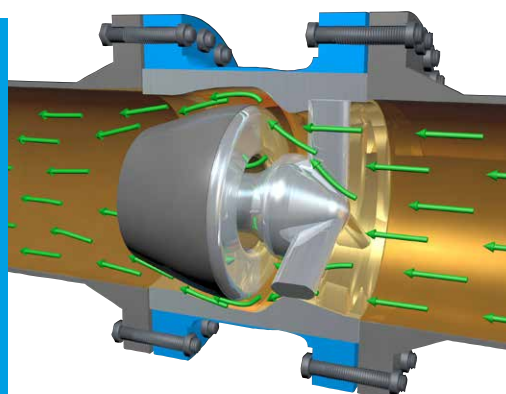

AXIAL CHECK VALVES



FM 00343



EMS 600979



OHS 600980



IMR 613512



Certificate No.
CE 55079



LNG



OFFSHORE



PIPELINE



PETROCHEMICAL

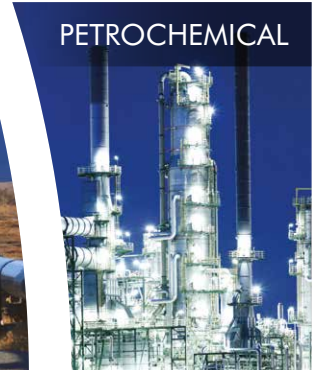

POWER

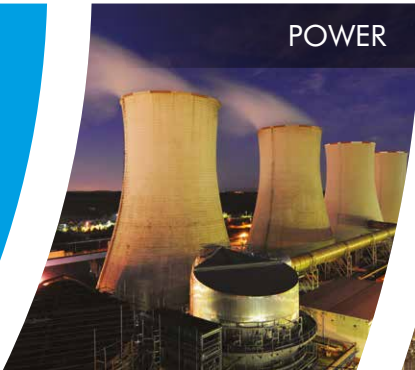

REFINERY

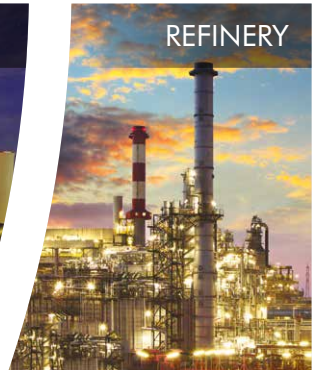

FPSO



CHEMICAL
& FERTILISERS

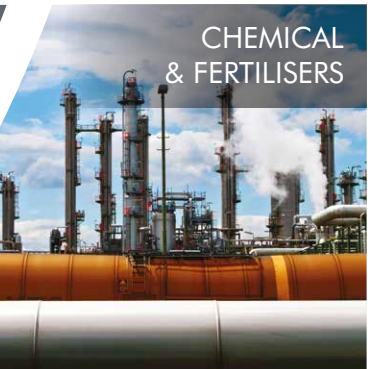

GOODWIN
INTERNATIONAL LTD

Newstead Industrial Estate, Trentham, Stoke-on-Trent, ST4 8HU, England

Tel +44 (0)1782 654000 Fax +44 (0)1782 208060 Email checkvalves@goodwingroup.com

www.checkvalves.co.uk

GIV-047 - 2000 1v6